



STEINEL®
PROFESSIONAL

senses for tomorrow

New products for 2018



senses for tomorrow.

The intelligent building of tomorrow will have entirely new capabilities. It will be more efficient, healthier, safer and more comfortable.

It will know what is going inside and outside. It will react, learn, and control itself and optimise its performance and it will open up entirely new opportunities for its inhabitants. The new revolutionary sensors from STEINEL SYSTEMS* such as True Presence® and the optical sensor HPD2 are the basis for building intelligence solutions that go way beyond simple illumination control. Check out two other highlights: The RS PRO Connect 5100 LED is the ideal diffuser luminaire with advanced Bluetooth technology for configuring and interconnecting the lights.

The DL Vario Quattro Pro LED is a world first outdoor light with 4 separately adjustable infrared sensors that lets you detect objects exactly where you want.

This makes switching errors a thing of the past.

We hope you enjoy the STEINEL New products for 2018 – be inspired!

True Presence®

Optical sensors

Light management

Sensors

Sensor-switched lights for indoors

Sensor-switched lights for outdoors

from page **6**

from page **20**

from page **26**

from page **32**

from page **34**

from page **42**

True Presence®
True Presence® Multisensor KNX
Multisensor Air KNX
Hallway

HPD2

LiveLink Control Box HCL
IR Quattro HD DALI plus

IR Quattro MICRO

RS PRO Connect 5100 LED
RS PRO LED P series

DL Vario Quattro PRO LED
L 690/L691 LED
L 330/331 LED



True Presence® People at the centre of a digital sensor revolution.

To be or not to be? What counts? What is really important? These are the questions we asked ourselves when we were pushing the further evolution of our sensor technology. Today's presence detectors actually are nothing more than enhanced motion sensors. And how can a motion sensor be improved even further? The answer came quickly: By concentrating on presence instead of motion. True presence means that a person is present – even when he is not moving. That really changes things. We took on the challenge. We met it.

True Presence® is the world's first true presence detector. It reliably detects the presence of a person. No matter what this person is doing: walking, standing, sitting, reading, resting or sleeping. This is real digital knowledge of presence or absence. This is essential information for existing or future building management.



True Presence® detects micro-movements resulting from the vital functions of a human. Even the slightest movement of the chest or shoulders when breathing is sufficient for a reliable detection.

The evolution of precision sensors.

True Presence®

IR Quattro HD

Presence detectors

Motion detectors



True Presence® Sensory organs for digitalisation.

Our True Presence® technology is based on detailed high-frequency measurements of the surroundings. The presence of humans is indicated when 3-dimensional breathing patterns (micro-movement resulting from vital functions) are detected. The combination of a highly sensitive antenna with unique sensor software results in a 100% detection of humans. The distance of the person to the sensor, the movement vector and the body posture is registered as well. And all of this so quickly and so precisely that an additional stay ON time is no longer required.

Sometimes it's the little details that result in major changes. Even when most people hardly notice presence detectors on the ceiling: the new True Presence® detectors will leave a lasting impression. The outstanding design indicates a revolution on the inside. True Presence® is the flagship of the presence detector evolution and opens up a new era in building sensor technology.

The true presence® product family combines revolutionary technology with an enhanced sensor design on a digital basis. And easy to control via app and Bluetooth.

True Presence® detects micro-movements resulting from the vital functions of a human.



Digital configuration of the detection zones and the sensor specifications.

Advanced high-frequency antenna with the highest resolution.



True Presence®

It is the first detector for identifying human presence. It reliably detects presence and absence of people in a 64m² area, the "True Presence®". At a previously unattainable 177 m², it has even been possible to triple its total presence detection zone over conventional presence detectors.

**True Presence®
Multisensor KNX**

True Presence® technology with enhanced senses for brightness, room temperature, humidity, radial object distance, approaching and moving away, CO2, VOC and air pressure – no secrets for this sensor.

Multisensor Air KNX

Good air makes people active and keeps people healthy. This extension of the True Presence® family concentrates on the detection of temperature, humidity, air pressure, volatile organic compounds (VOC), CO2 and brightness.

Hallway

Specialists are needed for long hallways and aisles. Hallway detects the movement vector as well as if someone is on the left or the right with a detection zone of 25 m.

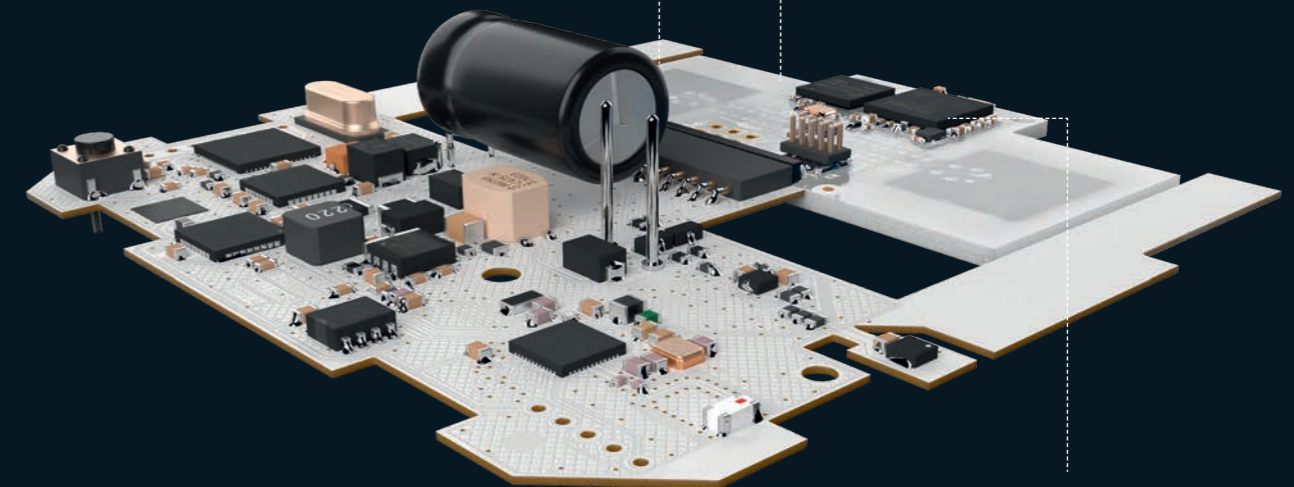

High-speed CPUs for sensor data evaluation.

True Presence® Solutions for more efficiency, health, safety and comfort.

Building intelligence starts with a sense, just like with humans. Sensors record data and transmit this to a central processing unit where it is analysed and evaluated. The information resulting from this analysis is then available for the technical actuators within the building. The intelligent building continuously collects this knowledge and continuously optimises the performance automatically.

True Presence® can detect true human presence in the room no matter what these people are doing. Long follow-up timing is not necessary anymore. The information "presence of humans" now becomes a control parameter for building automation. And even when this technology is already available on the market, it still has not revealed its full potential yet. Combining true presence® with the detection of temperature, humidity, VOC and brightness makes sensors real sensory organs and gives your building the information that is necessary for true **building intelligence**.

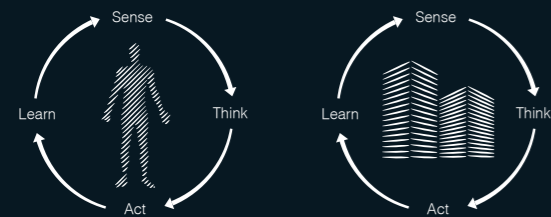

Occupancy and service management. Which room is available, which room is still occupied? It is embarrassing and inefficient when service personnel enter a room that is still occupied. The Hospitality-Solution lets you easily detect which rooms still have guests present and which do not. The Service is optimised and is much quicker.



Care room monitoring. The number of elderly people is constantly increasing. The special Elderly Care solutions let True Presence® reliably detect the vital functions of people that require care - it detects presence and absence as well as deviations from normal situations and problematic conditions.



Creating a good interior climate. The true presence® Multisensor KNX reliably analyses the room and provides the basis for optimal ventilation, air conditioning, shading and more. It creates a healthy atmosphere and makes sure that the lights stay on during classroom work.



Effective evacuation. Worst case scenario: A cruise ship or a Hotel need to be evacuated. But how can you ensure that no passengers are left behind? True Presence® can help determine which rooms still have people inside and which do not.

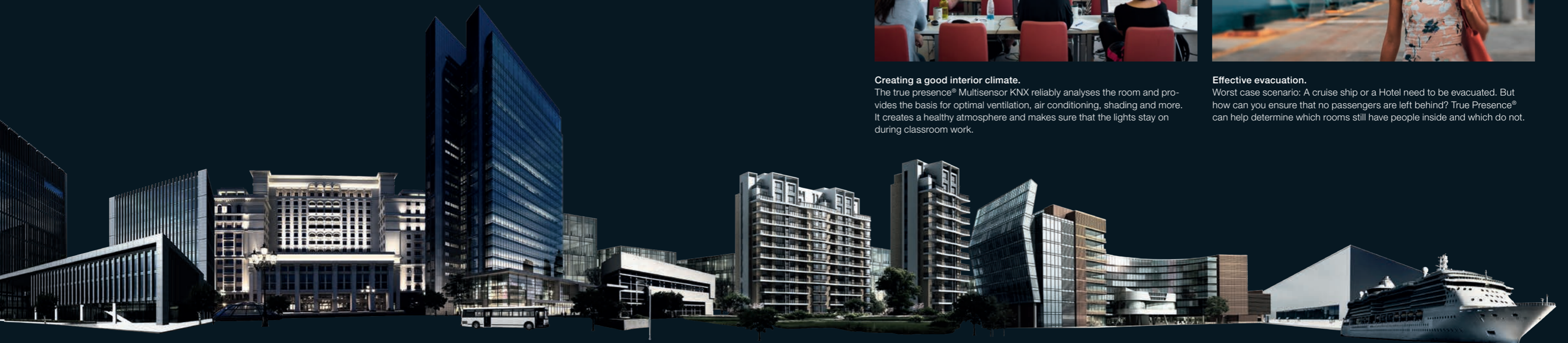

True Presence®

The first true presence detector.

Looking forward follows looking up. true presence® was developed to be the first true presence detector. It reliably indicates if a person is in the room or not. This means that reliable absence detection is possible for the first time. This information allows the reliable activation and deactivation of lighting without the need for stay ON times and without any waste of electricity. The detailed knowledge concerning presence and absence results in numerous other applications that can be very valuable for building management. This sets a new standard in advanced building automation.

- 
 True Presence
 Ø 9m
- 
 presence
 Ø 15m
- 
 movement
 Ø 15m
- 
 360°
- 
 5 JAHRE
 HERSTELLER
 GARANTIE
 manufacturer's
 warranty

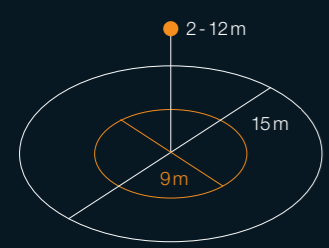

Mounting height 2 - 12 m
 True Presence®-zone Ø 9m / 64 m²
 Presence zone Ø 15m / 177 m²

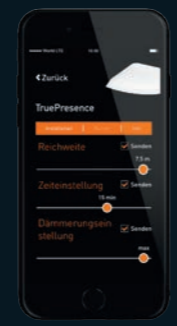

Technical specifications
 Dimensions (LxWxH):
 Surface installation 122.7 x 122.7 x 45 mm
 Concealed installation 103 x 103 x 50 mm
 Power supply: 220 - 240 V, 50 / 60 Hz

COM1 / COM2:
 Output COM1/COM2: max. 2000 W, max. 8 fluorescent lamps / LED lamps C < 176 µF
 Output COM2: max. 230 W / 230 V, max. 1 A

DALI:
 Output DALI: 1 x 2-conductor DALI-control line / broadcast for 64 electronic ballast
 KNX:
 Power supply: KNX bus voltage

Sensor type: high frequency
 Angle of coverage: 360°
 Reach: Ø 9 m true presence®, Ø 15 m presence, Ø 15 m motion (mounted at a height of 2.8 m)
 Twilight setting: 2 - 1000 lx
 Time setting: COM1 / COM2 / DALI:
 0 sec - 30 min, KNX: 0 - 255 min
 IP rating: IP20 (surface mounted) / IP54 (concealed mounting)
 Mounting height: 2 - 12 m
 Temperature: -20 to +50 °C; 0 to +40 °C (KNX)
 Material: UV-resistant plastic
 Network: wireless connection via Bluetooth
 KNX version - sensor detection variables:
 True Presence®, temperature, humidity, detection of movement vector and distance to the person

- True Presence®**
COM1 AP EAN 4007841 057916
COM1 UP EAN 4007841 057923
- COM2 AP** EAN 4007841 057930
COM2 UP EAN 4007841 057947
- DALI AP** EAN 4007841 057954
DALI UP EAN 4007841 057961
- KNX UP** EAN 4007841 056339

Distribution by STEINEL SYSTEMS only.
 Further information on request.

True Presence® Multisensor KNX. Seven senses for intelligent buildings.

The most precise presence detector ever becomes the ultimate sensory organ. Additionally to the true detection of people, brightness, ambient temperature, humidity, air pressure, volatile organic compounds (VOC) and CO₂ are available. Information that brings the digitalisation of building automation a great deal further. This combination makes the true presence® Multisensor KNX a good investment in building intelligence, a comfortable environment for people and real efficiency. The best comes from above – precise, digital information for an advanced building management.

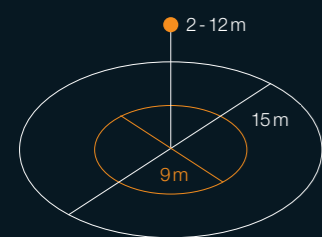
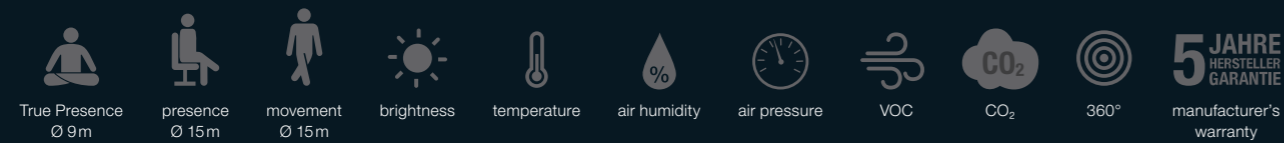

Mounting height 2 - 12 m
True Presence®-zone Ø 9m / 64 m²
Presence zone Ø 15m / 177 m²



Technical specifications

Dimensions (L x W x H): 123 x 123 x 31 mm
Power supply: KNX bus voltage
Sensor type: Multisensor
Angle of coverage: 360°
Reach: Ø 9 m true presence®, Ø 15 m presence, Ø 15 m motion (mounted at a height of 2.8 m)
Twilight setting: 2 - 1000 lx
Timer setting: 0 - 255 min
IP rating: IP20
Mounting height: 2 - 12 m
Temperature: 0 to +40°C

Sensor detection variables:

true presence®, brightness, temperature, humidity, air pressure, volatile organic compounds (VOC), CO₂, detection of movement vector and distance to the person
Material: UV-resistant plastic
Network: wireless connection via Bluetooth

True Presence® Multisensor KNX

EAN 4007841 056353

Distribution by STEINEL SYSTEMS only.
Further information on request.

Multisensor Air KNX

Concentrating on a healthy interior climate.

The true presence® product family sets new standards. The system is rounded off with sensors that provide additional information reliably. The Multisensor AIR KNX specialises in air, brightness and temperature detection. Without true presence® detection, but still with the modern unique look, it easily fits into the appearance of a modern building. The sensor with a sense for a good atmosphere.

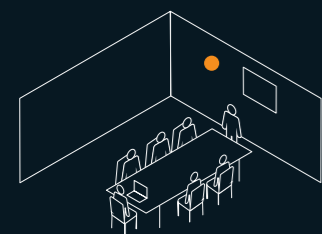

6 sensor detection variables for customised measurement



Technical specifications

Dimensions (L x W x H): 123 x 123 x 31 mm
 Power supply: KNX bus voltage
 Sensor type: Multisensor
 IP rating: IP20
 Temperature: 0 to +40 °C
 Sensor detection variables:
 Brightness, temperature, humidity, air pressure,
 volatile organic compounds (VOC), CO₂,
 Material: UV-resistant plastic
 Network: wireless connection via Bluetooth







Multisensor Air KNX
 EAN 4007841 056346

Distribution by STEINEL SYSTEMS only.
 Further information on request.

Hallway

The specialist for long hallways and aisles.

The better hallway sensor knows more. Movement vector (coming and going) as well as if someone is on the left or the right. And this with a detection zone of 25 m. Naturally, the reach can also be adjusted in both directions. It provides more information than any other hallway sensor. Bluetooth technology ensures that the Hallway can be configured and interconnected into existing networks conveniently. And the distinguished design makes it an important member of the true presence® family.

-  360°
-  max. 25 x 3 m
-  2 - 1000 Lux
-  5sec - 15min
-  0 - 255min
KNX-Version
-  **5 JAHRE**
HERSTELLER
GARANTIE
manufacturer's
warranty

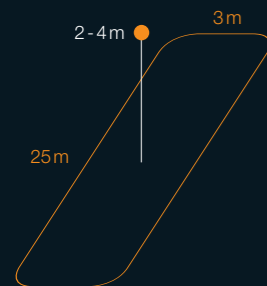

Mounting height 2 - 4 m
Detection zone 25 m / 75 m²



Technical specifications

Dimensions (LxWxH):
Surface mounting: 122.7 x 122.7 x 61.9 mm
Concealed installation: 102.7 x 102.7 x 66.5 mm
Power supply: 220 - 240 V, 50 / 60 Hz

COM1 / COM2
Output COM1/COM2: max. 2000 W, max.
8 fluorescent lamps / LED lamps C < 176 µF
Output COM2: max. 230 W / 230 V, max. 1 A

DALI:
Output DALI: 1 x 2-conductor DALI-control line /
broadcast for 64 electronic ballast

KNX:
Power supply: KNX bus voltage

Sensor type: high frequency
Angle of coverage: corridor, both directions
Reach: min. 3 x 2 m, max. 3 x 12.5 m in all
directions

Twilight setting: 2 - 1000 lx
Time setting: COM1 / COM2 / DALI:
0 sec - 30 min, KNX: 0 - 255 min
IP rating: IP54 concealed installation / IP20
surface installation
Mounting height: 2 - 4 m
Temperature: -20 to +50°C; 0 to +40°C (KNX)
Material: UV-resistant plastic
Network: wireless connection via Bluetooth

Hallway

COM1 AP EAN 4007841 057978
COM1 UP EAN 4007841 057985

COM2 AP EAN 4007841 057992
COM2 UP EAN 4007841 058005

DALI AP EAN 4007841 058012
DALI UP EAN 4007841 058029

KNX UP EAN 4007841 058036

Distribution by STEINEL SYSTEMS only.
Further information on request.

HPD 2

We taught our sensor how to count.
And you have no idea about all the things made possible by this.

What is happening where? How great would that be when a sensor could tell you that. The HPD2 with optical presence technology can. Anywhere where you want to know how many people are present at a certain location, the HPD2 can provide the appropriate information. Information in a dimension that still is to fully explored. Digitalisation and interconnection in building automation is gathering ever more speed. This includes sensory organs that enable the analysis of individual areas. How many employees are in the office? Who is sitting where? Are there any delays in front of the elevators? What is the frequency in the stairways? Is there a queue at the checkout? There are an unlimited number of examples that show how important it will be to know more and more within the building. The right information is not only needed for interaction within the building automation, but also for the organisation and optimisation of processes. The HPD2 can deliver this information. reliably and precisely.



Optical sensors deliver information concerning the number and position of people.



HPD2

One sensor, five zones
and many good reasons for optical sensors.

Saving energy, optimising costs, creating an atmosphere, protecting health, promoting motivation, improving processes, enhancing satisfaction, analysing failures, protecting resources, ...
Once you grasp the concept you begin to understand why we just had to develop the HPD2.
It goes way beyond simple illumination. Its all about information and its analysis.

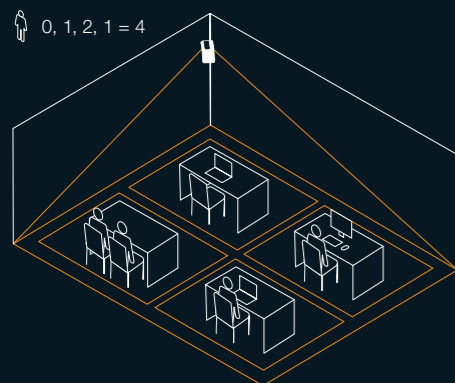

Areas can be divided into 5 detection zones.

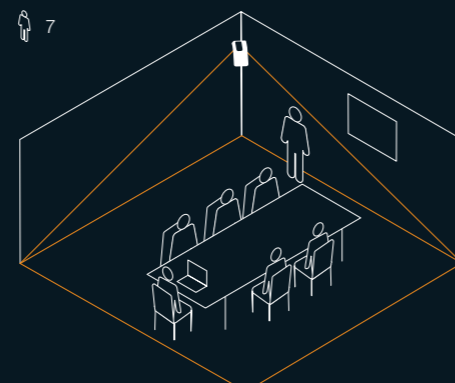

Reliable detection of the number of people in a room.

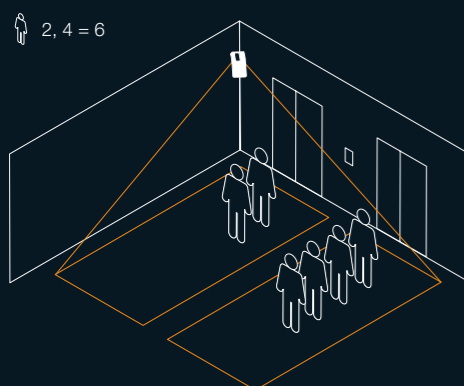

Live information concerning utilization and frequency.



What? How many?
Where? When?
More intelligence with optical
multi-sensor systems.

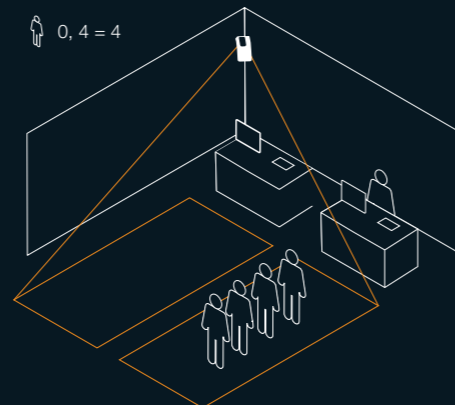

Data processing for situation-analysis.



1. Organising flexible workplaces.

A workplace in a large city can cost 10,000 € a year and more. And sometimes not even half of these workplaces are effectively occupied. The Desk Sharing solution lets you know at a glance where there still are places available and where not. Idea: Increase the utilisation rate and save money.



2. Managing conference rooms.

Which conference rooms are available? Which are occupied? Where is the meeting? Our Meeting-Room solution allows you to quickly and reliably detect the utilisation and can even provide information on how many people are in the respective room.



3. Efficient elevator management.

Put an end to long waiting times at the elevator! The HPD2 can tell you exactly how many people are waiting for the elevator. And how many people are already inside the elevator. Using this information a full elevator can pass through a populated waiting area in order to return as quick as possible when empty.



4. Optimising queues.

Nobody likes to stand in a queue. Not at the checkout in the supermarket, and not during lunch break in the cafeteria. The Waiting Line solution opens new checkouts and allocates personnel in order to eliminate queues as soon as possible.

HPD 2

What? How many? Where? When? More intelligence with optical multi-sensor systems.

The world's best specialists and universities have developed this system, which analyses images directly in the sensor. With the HPD2 – HPD stands for "Human Presence Detection" – STEINEL makes a quantum leap in sensor technology. Because the HPD2 is the world's first presence detector that is not only capable of detecting whether people are present but can also count them. No matter whether they are moving about or not. At the heart of the person sensor is innovative technology that uses a highly sensitive optical system in combination with a complex mathematical algorithm. The HPD2 also has integrated temperature and air-humidity sensors, opening up completely new possibilities in building automation. Light, heating and air-conditioning can finally be controlled in line with demand for the number of people present in a room.

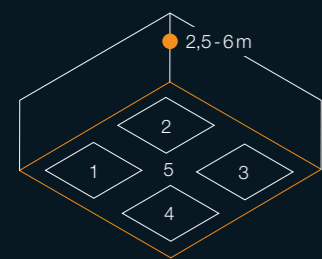
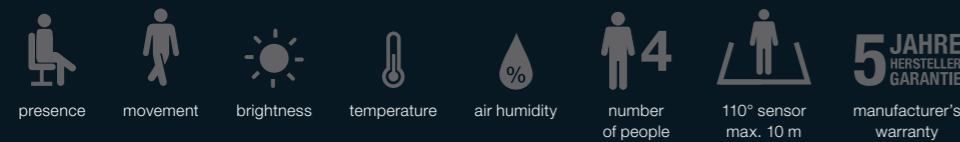

Mounting height (wall) 2.5-6 m
up to 5 zones can be adjusted



Technical specifications

Dimensions: (H x W x D): 156 x 86 x 52 mm
 Power supply: KNX-bus voltage + auxiliary voltage 18-57 V DC, 130 mA bus current
 IP: Power over Ethernet (PoE)
 Sensor type: optical sensor
 Angle of coverage: 110°
 Reach: max. radius 10 m
 Twilight setting: 2 - 2000 lux
 Time setting: 1 - 255 min

Communication objects HPD 2
 KNX twisted pair:
 Light channel with constant-lighting control per zone

Number of people present for up to 5 zones
 Threshold control possible
 Output of temperature, air humidity and light level
 Presence output
 Output of the values for all zones accumulated

IP (via Rest-API)
 Output of the compiled sensor data
 Number of persons in total / per zone
 Light level total / per zone
 Presence
 Temperature
 Air humidity
 Brightness

IP rating / protection class: IP20 / III
 Temperature range: 0°C to +40°C
 Material: UV-resistant plastic

HPD 2
 KNX Twisted Pair EAN 4007841 033200
 IP EAN 4007841 033965

Distribution by STEINEL SYSTEMS only.
 Further information on request.



LiveLink

Human Centric Lighting (HCL)
As of today a fixed element within the LiveLink
product range.

People at the centre. Modern illumination concepts try to have a positive influence on the well-being of the human being. Artificial lighting that follows natural characteristics in terms of changing brightness and colours can have a positive effect on effectiveness and concentration of the individuals. Human Centric Lighting (HCL) is now also available for LiveLink and complements the light management system with a further important feature.

LiveLink - full flexibility for today and tomorrow.



LiveLink Control Box HCL

It is equipped with the HCL software as well as a DALI interface and can be controlled via tablet, smartphone or switch. It can operate up to 16 light groups and 64 individual components. An integrated, autonomous Wi-Fi network provides optimum connection and security.

EAN 4007841 055455

DALI plus. The gateway to intelligent lighting control.

Integrating a complete control unit into the load section of a sensor has enabled us to combine the key functions for DALI-based lighting control for straightforward installation and use. This provides an easy, fast and cost-effective way of providing solutions for many different applications. DALI plus – developed for everyone wanting to create and quickly implement innovative lighting management.

For classrooms, cubicle areas or single offices: Our DALI plus solution is both easy to use and effective. With intelligent sensors that come with a complete lighting control module. The control unit fitted in the load section makes installation both fast and easy. Using the Smart Remote, you can control up to 64 luminaires via 3 lighting channels by app. DALI plus is the ideal solution for anyone wishing to plan and install intelligent lighting with just a few components.



IR Quattro HD DALI plus. Pure intelligence – installed in a single sensor.

The intelligent IR Quattro HD DALI plus presence detector is the brains of the DALI plus system. With a mounting height of 2 to 10 metres, it can be used anywhere. It has 3 lighting channels (DALI addressable) and can control up to 64 luminaires. The additional dry contact enables addressing switchable lights, HLK control and standby circuits. The integrated button interfaces allow switching and dimming of the light channels. All configurations, including constant-lighting control and variable basic light functions, can be controlled via Smart Remote for added user convenience.

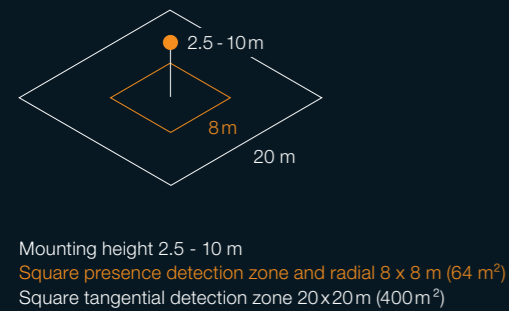

Smart Remote ready



Technical specifications

Dimensions (L x W x H):
 Surface mounted: 120 x 120 x 65 mm
 Ceiling installation: 120 x 120 124 mm
 Power supply: 220 - 240 V, 50 / 60 Hz
 Power consumption; max. < 0.5 W (without DALI participants)
 DALI supply current: max. 150 mA
 DALI-Communication: max. 64 participants, Addressable (max. 3 groups) broadcast
 Sensor type: passive infrared
 Square detection zone, for presence: max. 8 x 8 m (64 m²)
 Square detection zone, radial: max. 8 x 8 m (64 m²)

Square detection zone, tangential: max. 20 x 20 m (400 m²)
 Twilight setting: 10 - 1000 lx
 Time setting: 5 sec - 60 min
 Basic light: OFF, 10 - 60 min, all night, 10-50% selectable
 IP rating: IP20
 Mounting height: 2.5 - 10 m
 Temperature: 0 to +40°C
 Material: UV-resistant, paintable
 Accessories: Smart Remote

IR Quattro HD DALI plus
 Surface mounted EAN 4007841 035273
 In-ceiling installation EAN 4007841 035204

IR Quattro MICRO

Small, precise and effective.

Required by planners and architects, made by STEINEL. The IR Quattro MICRO fulfills many wishes. Its small size and the low profile design make it perfect for applications where disturbing installations on the ceiling are to be avoided. The size of the micro-precision lens is just 15 x 15 mm. And its performance is nevertheless stunning. The 360° infrared presence detector detects 36 m². And the IP65 classification lets you install it in rooms that are subject to moisture. The IR Quattro MICRO – our smallest unit with high potential.

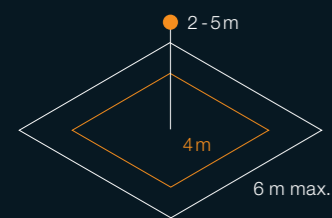
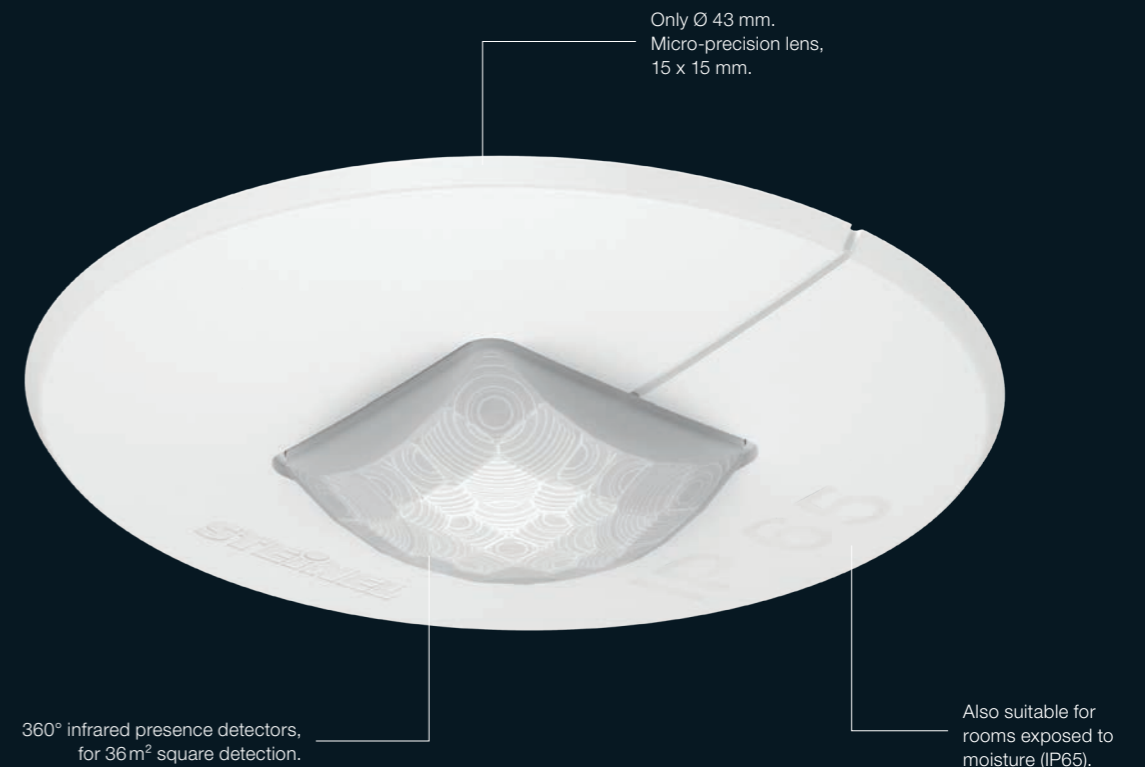

Mounting height 2 - 5 m
 Square presence detection zone 4 x 4 m (16 m²)
 Square detection zone, tangential and radial: 6 x 6 m (36 m²)



Smart Remote ready



Technical specifications

Dimensions (ØxH): Ø 43.1 x 75.4 mm
 Cable connection: Ø 32.6 (33.5) x 100 mm

COM1
 Power supply: 220 - 240 V, 50 / 60 Hz
 Output: max. 1000 W, max. 8 fluorescent lamps / LED lamps C<176 µF

DALI-2
 Power supply: DALI bus voltage
 Current consumption: 2 DALI users (4 mA)

KNX:
 Power supply: KNX bus voltage

Sensor type: passive infrared
 Angle of coverage: 360°
 Reach: presence and radial 4 x 4 m, tangential 6 x 6 m
 Twilight setting: 2 - 1000 lx
 Time setting: COM1: 30 sec - 60 min, KNX: 1-255 min
 IP rating: IP65
 Recommended mounting height: 2 - 5 m
 Temperature: -25°C to 55°C

Material: UV-resistant plastic (casing), HDPE (lens)
 Accessories: Smart Remote, COM1: remote control RC5/RC8, KNX: remote control RC6/8

IR Quattro MICRO
 COM1 EAN 4007841 053789
 DALI-2 EAN 4007841 053864
 KNX EAN 4007841 053871

RS PRO Connect 5100 LED

This world has way too many old linear lighting systems. Lets get rid of this backlog.

Ready for change in parking facilities, halls, garages, hallways and all other rooms that still are equipped with antique diffuser luminaires. It is so easy: Use the existing cables, attach to the existing holes, wirelessly configure the new installation and adjust all parameters via the easy-to-use app. The result: State-of-the-art illumination based on the old installation, advanced user friendliness with many features and immediate cost reduction due to the greatest level of efficiency. And to top it all: Genuine bright light and an emergency version upon request.

Read the facts for yourself:

Luminaire

- Sensor-switched LED diffuser luminaire
- 30 W with 4206 lumens
- 4000K neutral white
- 140lm/W
- For rugged applications
- IP66 / IK07
- LED 60 000 h | L80B10
- also available as emergency light version
- Basic light level 10 - 50 %
- Main light level 50 - 100 %

Sensor

- 360° HF sensor
- Ø 12 m reach
- Optional shielding plate
- No unintentional deactivation through presence mode

Connectivity

- Wireless integration in network
- Connection via Bluetooth
- Configurable via app
- Neighbouring-light function for lighting the way ahead
- Group configuration

RS PRO Connect 5100 LED

Perfect for modernisation and refurbishment.

Our engineers were sure about this: the new diffuser luminaire was supposed to be simple and good. Easy to install, easy to maintain, and top notch in terms of efficiency, function and quality. The result: RS PRO Connect 5100 LED. The diffuser luminaire the world was waiting for. Sturdy, highly functional, easy to install, with wireless networking and subsequently easy to configure via app.

- LED**
36 years (Ø 4.5h/day)
- 360°
- Ø 1 - 12 m
- 30 w**
4206 lm
140 lm/W
- 4000 K
neutral-white
- 2 - 2000 Lux
- 5 sec - 60 min
- IP66
- IK07
- connectable via bluetooth
- 5 JAHRE HERSTELLER GARANTIE**
manufacturer's warranty

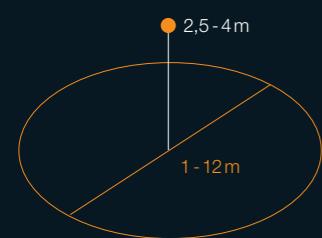
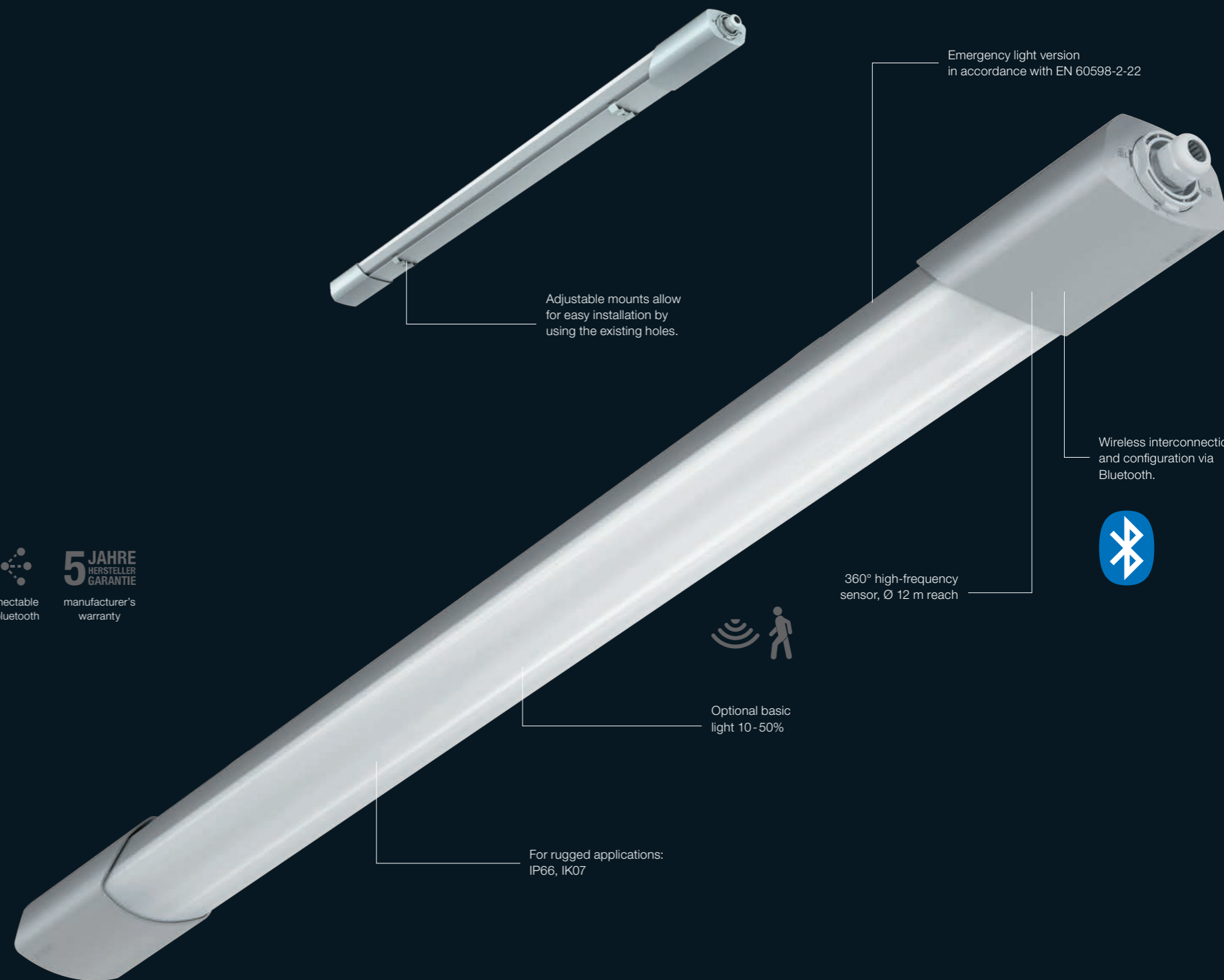

Mounting height 2,5 - 4 m
Detection zone Ø 1 - 12 m / 113 m²



Technical specifications

Dimensions (L x W x H): 1,370 x 87 x 58 mm
 Emergency light: 1,470 x 87 x 58 mm
 Power supply: 220 - 240 V, 50 / 60 Hz
 Output: 30 W
 Luminous flux: 4206 lm
 Efficiency: 140 lm/W
 Colour temperature: 4000 K / SDCM 3
 Colour rendering index CRI: Ra ≥ 80
 LED cooling system: Passive Thermo Control
 LED life expectancy: 60,000 h (L80B10 to LM80)
 Sensor type: high frequency*
 Angle of coverage: 360°*
 Reach: Ø 1 - 12 m, infinitely variable,

can be limited in 4 directions*
 Twilight setting: 2 - 2000 lx*
 Time setting: 5 sec - 60 min
 Impact resistance: IK07
 Basic light: 10 - 50%
 Main light: 50 - 100%
 Interconnection: Via Bluetooth
 IP rating: IP66
 Protection class: II
 Material: UV-resistant plastic with PC cover
 Temperature range: -20°C to +40°C

*Sensor and emergency light version

RS PRO Connect 5100 LED
Master EAN 4007841 052911
Slave EAN 4007841 052904
Emergency light EAN 4007841 058708

RS PRO **LED** P series

The round must be in square. Our successful indoor light is now available in 18 versions.

Never change a winning team. On the contrary. We are shifting gears with our popular entry level light. 18 versions in three different sizes satisfy any wish you might have. Master-slave installations and emergency light versions can be installed easily and quickly. The ideal sensor-switched light for an unlimited number of applications in a modern interior design. **Professional quality for a reasonable price. What more could you ask for?**

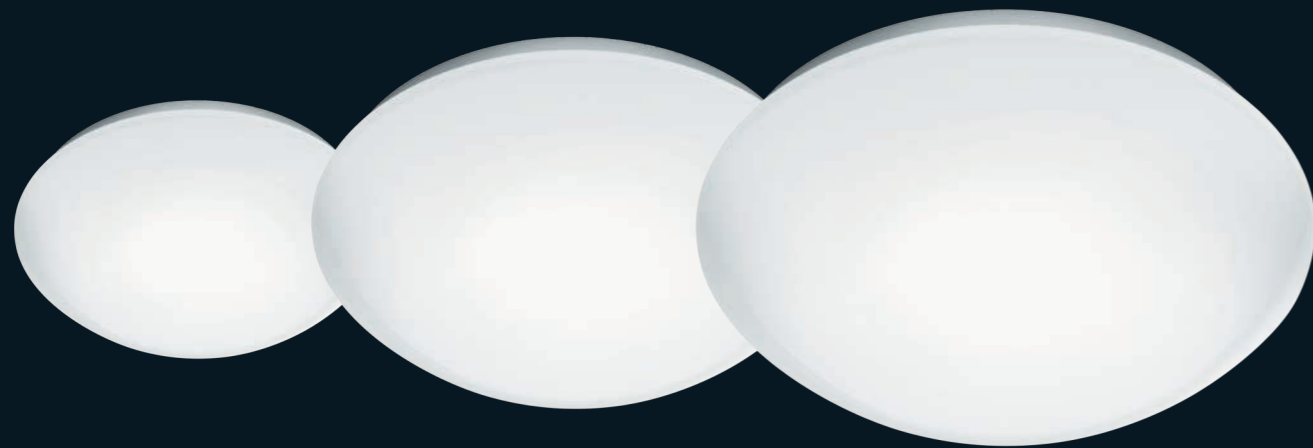

| | RS PRO LED P1 | RS PRO LED P2 | RS PRO LED P3 |
|----------------------------|---------------------|-----------------------|-----------------------|
| Dimensions (Ø x H): | Ø 280 x 110 mm | Ø 320 x 110 mm | Ø 400 x 142 mm |
| Output | 9.5 W / 9 W (slave) | 16 W / 15.5 W (slave) | 20 W / 19.5 W (slave) |
| Luminous flux 4000 K | 1010 lm | 1730 lm | 2190 lm |
| Luminous flux 3000 K | 960 lm | 1610 lm | 2040 lm |
| Efficiency | max. 112 lm/W | max. 112 lm/W | max. 112 lm/W |
| EAN Sensor 4000 K | 4007841 056032 | 4007841 056070 | 4007841 056117 |
| EAN Sensor 3000 K | 4007841 056063 | 4007841 056100 | 4007841 056148 |
| EAN Slave 4000 K | 4007841 056049 | 4007841 056087 | 4007841 056124 |
| EAN Slave 3000 K | 4007841 056056 | 4007841 056094 | 4007841 056131 |
| EAN emergency light 4000 K | 4007841 058555 | 4007841 058579 | 4007841 058593 |
| EAN emergency light 3000 K | 4007841 058562 | 4007841 058586 | 4007841 058609 |



RS PRO LED P1/P2/P3

A perfect solution for the right light in the right place.

Today, indoor lighting solutions are in demand that not only provide the last word in convenience and intelligent technology but also integrate harmoniously into the particular interior design. We have found the perfect answer in the RS PRO LED P1. Timeless design and very easy installation combined with pioneering technology and maximum efficiency. Because with the virtually invisible 360-degree high-frequency sensor always switching the max. 20 W LED lighting system ON reliably and in absolute silence, the indoor light is a real bonus for any building, both from the aspect of aesthetic appeal as well as cost efficiency. The new slave versions are quickly and easily interconnected via cable.

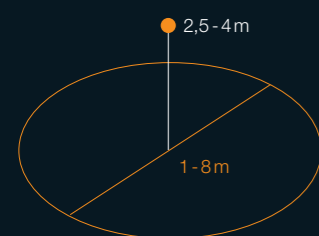
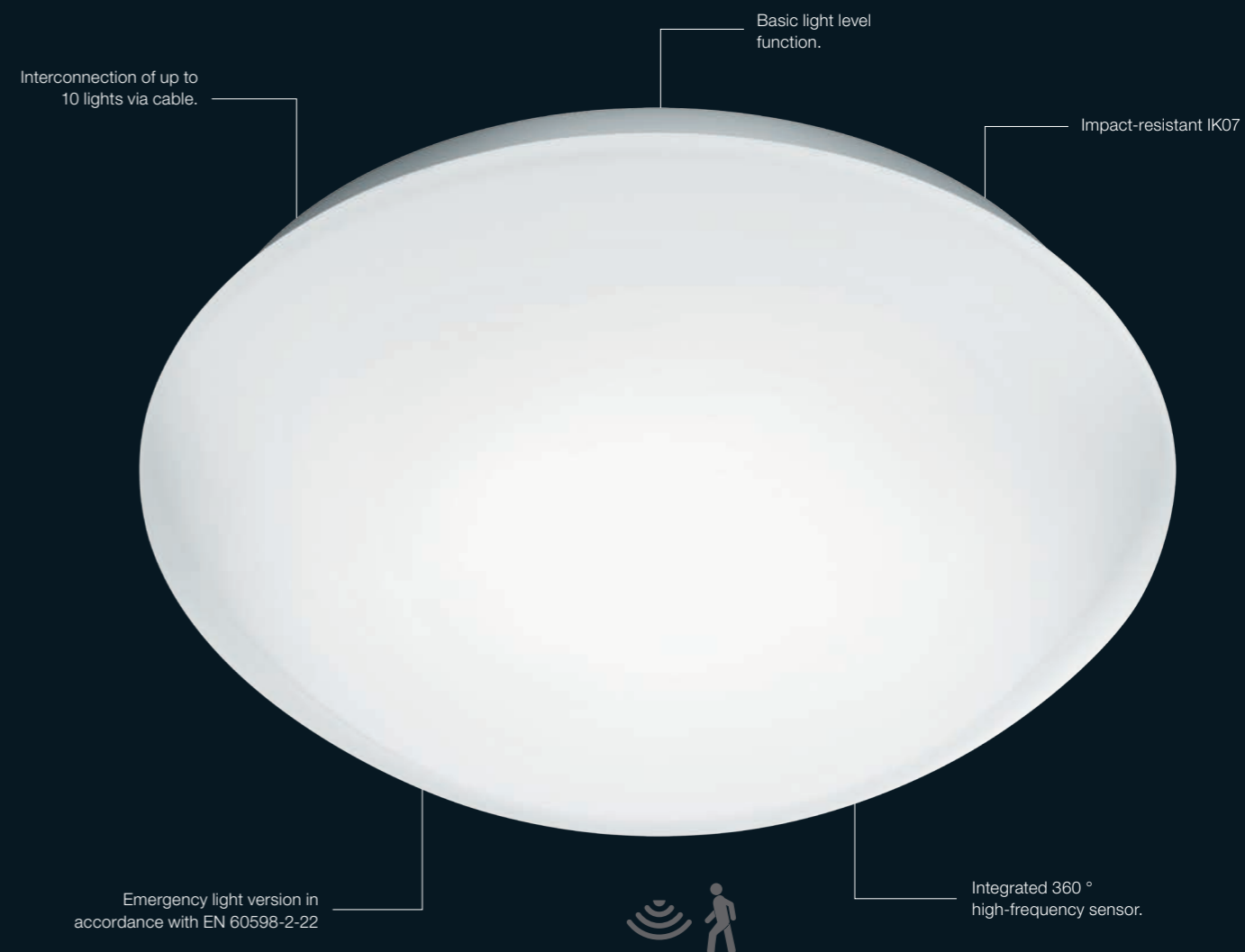

Mounting height 2.5 - 4 m
Detection zone Ø 1 - 8 m / 50 m²

Technical specifications
 Dimensions (ØxH): Ø 280 x 110 mm (P1)
 Ø 320 x 110 mm (P2)
 Ø 400 x 142 mm (P3)
 Power supply: 220 - 240 V, 50 / 60 Hz
 Output*: 9.5 W (P1), 16 W (P2), 20 W (P3)
 Luminous flux:
 max. 1010 Lumen, 106 lm / W (P1)*
 max. 1730 Lumen, 108 lm / W (P2)*
 max. 2190 Lumen, 109 lm / W (P3)*
 Colour temperature NW: 4000 K / SDCM 3
 Colour temperature WW: 3000 K / SDCM 3
 Colour rendering: Ra ≥ 80
 LED cooling system: Passive Thermo Control

LED life expectancy: 50,000 h (L70B10 to LM80)
 Sensor type: high frequency*
 Angle of coverage: 360°*
 Reach: Ø 1 - 8 m, infinitely variable, can be limited in 4 directions*
 Twilight setting: 2 - 2000 lx*
 Time setting: 5 sec - 15 min
 Soft light start: Yes
 Impact resistance: IK07
 Basic light: Dimmed to 10%, off, 10/30 min., all night long*
 IP rating: IP54
 Protection class: II
 Interconnection: by cable Material: UV-resistant

plastic and PMMA cover
 Temperature range: -10°C to +40°C

*Sensor- and emergency light version

RS PRO LED P series
 EAN see overview page 38/39

DL Vario Quattro PRO LED

The Outdoor Light that solves all of your problems.

Spot on rather than a rough estimate. This was the goal of our engineers when developing the DL Vario Quattro PRO LED. Switching errors within a large detection zone should be avoided. Thanks to the four integrated precision infrared sensors that can be mechanically adjusted individually in four directions, the DL Vario Quattro PRO LED is capable of detecting precisely where it is necessary. The reach can also be adjusted accurately between 2 and 8 m, meaning that neighbouring streets and pathways can be excluded from the detection zone. From the outside, the sensor lenses integrated in the light diffuser are only recognizable as a subtle honeycomb structure and round off the clean design of the light without any obstructions from sensor elements. **Another STEINEL invention that reliably provides light precisely where you need it.**



World first:

The light diffuser with a patented honeycomb structure also acts as the sensor lens.



DL Vario Quattro PRO LED

Detects precisely where you want it to.

The LED ceiling light with precise detection. The four infrared sensors can be mechanically adjusted in each direction between 2 to 8 m. The 360° all-round detection is ideally suited for optimum adjustment to the local conditions, e.g. carports and overhanging roofs. The light diffuser also acts as the sensor lens - a patented world first. The ceiling light illuminates with 1430 lm at an output of 14 W and can be mounted at heights of up to 6 m, including a convenient basic light function (10%) at twilight. The DL Vario Quattro PRO LED can be easily connected to the network via cable (up to 10 lights). Available in neutral white (4000K) and warm white (3000K) colour temperatures.

LED 14w

- 30 years (Ø 4.5h/day)
- 1430 lm / 102 lm/W
- Infrared sensor ideal 12x12m
- 2 - 1000 Lux
- 5sec - 30min
- manual override
- IP54
- IK07
- connectable via cable
- soft light start
- 5 JAHRE HERSTELLER GARANTIE

Easy and fast installation.

World first
No visible sensor: light diffuser is also the sensor lens.

Interconnection of up to 10 lights via cable.

Night-light function at twilight.

4 infrared sensors that can be individually configured

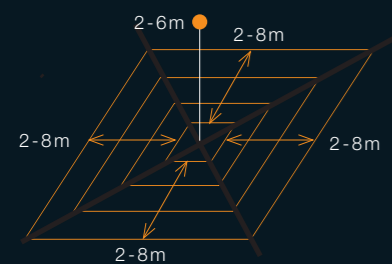

Mounting height 2.5 - 6 m
Detection zone in four directions adjustable from 2 - 8 m

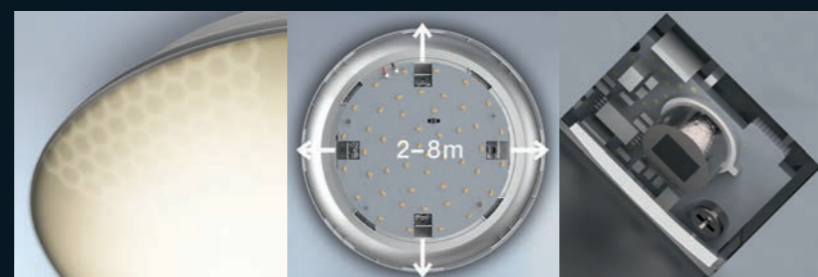

Integrated sensor lenses as patented world first Reach setting from 2-8 m in any direction 4 infrared sensors that can be individually configured

Technical specifications

Dimensions (ØxH): Ø310x69mm
 Power supply: 220 - 240 V, 50 / 60 Hz
 Output: 14 W
 Luminous flux: 1430 lm
 Efficiency: 102 lm/W
 Colour temperature: 3000 K / SDCM 3
 Colour temperature: 4000 K / SDCM 3
 Colour rendering: Ra ≥ 80
 LED cooling system: Active Thermo Control
 LED life expectancy: 50,000 h (L70B10 to LM80)
 Sensor type: passive infrared
 Angle of coverage: 360°
 Reach: 12 x 12 m detection zone at a mounting height of 2.5 m,

can be reduced to 4 x 4 m
 Twilight setting: 2 - 1000 lx
 Time setting: 5 sec - 30 min
 Soft light start: Yes
 Impact resistance: IK07
 Basic light level: 10%
 Manual override: selectable, 4 h
 IP rating: IP54
 Protection class: II
 Interconnection: Via cable
 Material: UV-resistant plastic and HDPE diffuser
 Mounting height: max. 6 m
 Temperature range: -20°C to +35°C

DL Vario Quattro PRO LED 4000 K (NW)
 EAN anthracite 4007841 057589
 EAN silver 4007841 035495

DL Vario Quattro PRO LED 3000 K (WW)
 EAN anthracite 4007841 057596
 EAN silver 4007841 035433

L 690 / L 691 LED

Timelessly beautiful. And extremely tough.

The square is one of the most popular shapes anywhere in and around the home. This is why it's only logical for STEINEL to believe in this familiar design that people like. And combine it with innovative LED and sensor technology. Just like all of STEINEL's Sensor-switched outdoor LED lights, the L 690 LED comes with the full range of functions too: basic brightness, soft light start as well as adjustable time and twilight threshold. Due to the high demand, we took a good look at the L 690 and the 691 LED and equipped this system with even better illumination characteristics and even better efficiency. The lamps can also be connected to the network via cable. This makes this robust and solid outdoor light a pleasure to work with in the professional environment.

LED 8.7w

30 years
(Ø 4.5h/day) 753 lm
86,6 lm/W



3000 K
warm-white



360°



max. radius
8m



2 - 1000 Lux



5 sec - 15 min



connectable
via cable



manual
override



soft light
start



5 JAHRE
HERSTELLER
GARANTIE
manufacturer's
warranty

Interconnectable
by cable.

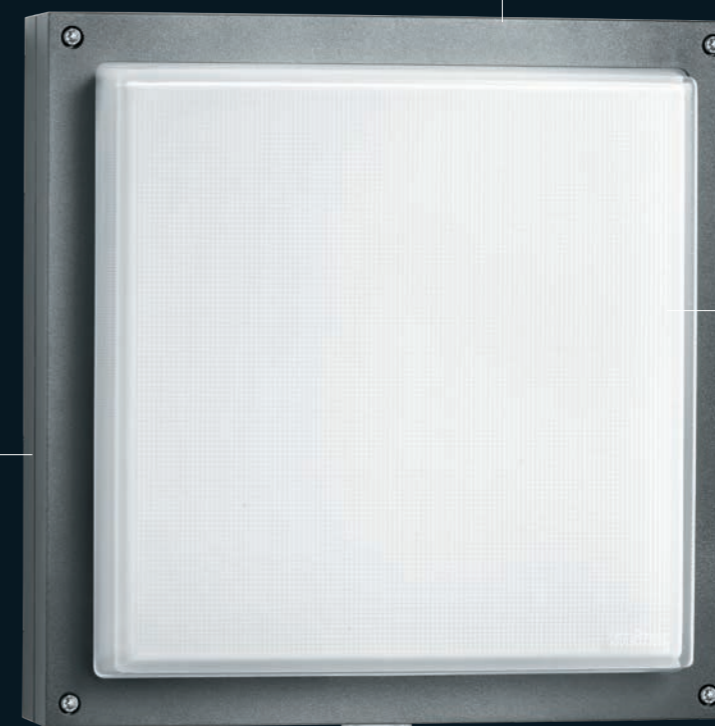

High-quality aluminium base
with impact proof PMMA cover.

Integrated basic
light function.



360° infrared
mini-sensor with
4 programs.

Light update:

Now even brighter and
even more efficient.
753 lumens / 8.7 watts



L 691 LED
With mesh guard for
the cover.



Mounting height 2 m
Detection zone Ø max. 16 m



Including sheet of self-adhesive
house numbers

Impact-resistant IK07
Infrared mini-sensor with
4 programs

Technical specifications

Dimensions (L x W x H):
104 x 291 x 306 mm (L 690 LED)
126 x 291 x 306 mm (L 691 LED)
Power supply: 220 - 240 V, 50 Hz
Output: 8.7 W
Luminous flux: 753 lm
Efficiency: 86.6 lm/W
Colour temperature: 3000 K / SDCM 3
Colour rendering index CRI: Ra ≥ 80
LED cooling system: Passive Thermo Control
LED life expectancy: 50,000 h (L70B10 to LM80)
Sensor type: passive infrared
Angle of coverage: 360°
Reach: max. radius 8 m
Twilight setting: 2 - 1000 lx

Time setting: 5 sec - 15 min
Manual override: selectable, 4 h
Basic light level: 10%
Soft light start: Yes
Interconnection: by cable
IP rating: IP44
Protection class: II
Material: aluminium base
with PMMA-cover
Temperature range: -10°C to +50°C
Capability of masking out individual segments
possible: Yes
Impact resistance: IK07
Accessories: incl. sheet of house numbers
(L 690 LED)

L 690 LED
EAN 4007841 053000

L 691 LED
EAN 4007841 053031

L 330 / L 331 LED

Stylish, practical and impact-resistant.

The L 330 LED and L 331 LED sensor-switched outdoor lights bring pleasant, even lighting to your outside wall. Sleek, minimalist design makes it particularly suitable for driveways, garages or stairwells, and the round lamp cover distributes light for illumination that's full of atmosphere. Incidentally, we have given these lights the very latest control system that's even capable of synchronizing several lights. The lamps can also be connected to the network via cable. This makes this robust and solid outdoor light a pleasure to work with in the professional environment.

LED 8.7 w

30 years
(Ø 4.5h/day) 753 lm
86,6 lm/W



3000 K
warm-white



360°



max. radius
8 m



2 - 1000 Lux



5 sec - 15 min



connectable
via cable



manual
override



soft light
start



5 JAHRE
HERSTELLER
GARANTIE
manufacturer's
warranty



Mounting height 2 m
Detection zone Ø max. 16 m



Impact-resistant IK07

Infrared mini-sensor with
4 programs

Technical specifications

Dimensions (L x W x H):
109 x 253 x 270 mm (L 330 LED)
124 x 253 x 270 mm (L 331 LED)
Power supply: 220 - 240 V, 50 / 60 Hz
Output: 8.7 W
Luminous flux: 753 lm
Efficiency: 86.6 lm/W
Colour temperature: 3000 K / SDCM 3
Colour rendering index CRI: Ra ≥ 80
LED cooling system: Passive Thermo Control
LED life expectancy: 50,000 h (L70B10 to LM80)
Sensor type: passive infrared
Angle of coverage: 360°

Reach: max. radius 8 m
Twilight setting: 2 - 2000 lx
Time setting: 5 sec - 15 min
Manual override: selectable, 4 h
Basic light level: 10%
Soft light start: Yes
Interconnection: by cable
IP rating: IP44
Protection class: II
Material: aluminium base with PMMA-cover
Temperature range: -10°C to +50°C
Capability of masking out individual segments possible: Yes
Impact resistance: IK07

L 330 LED
EAN 4007841 053079

L 331 LED
EAN 4007841 053093

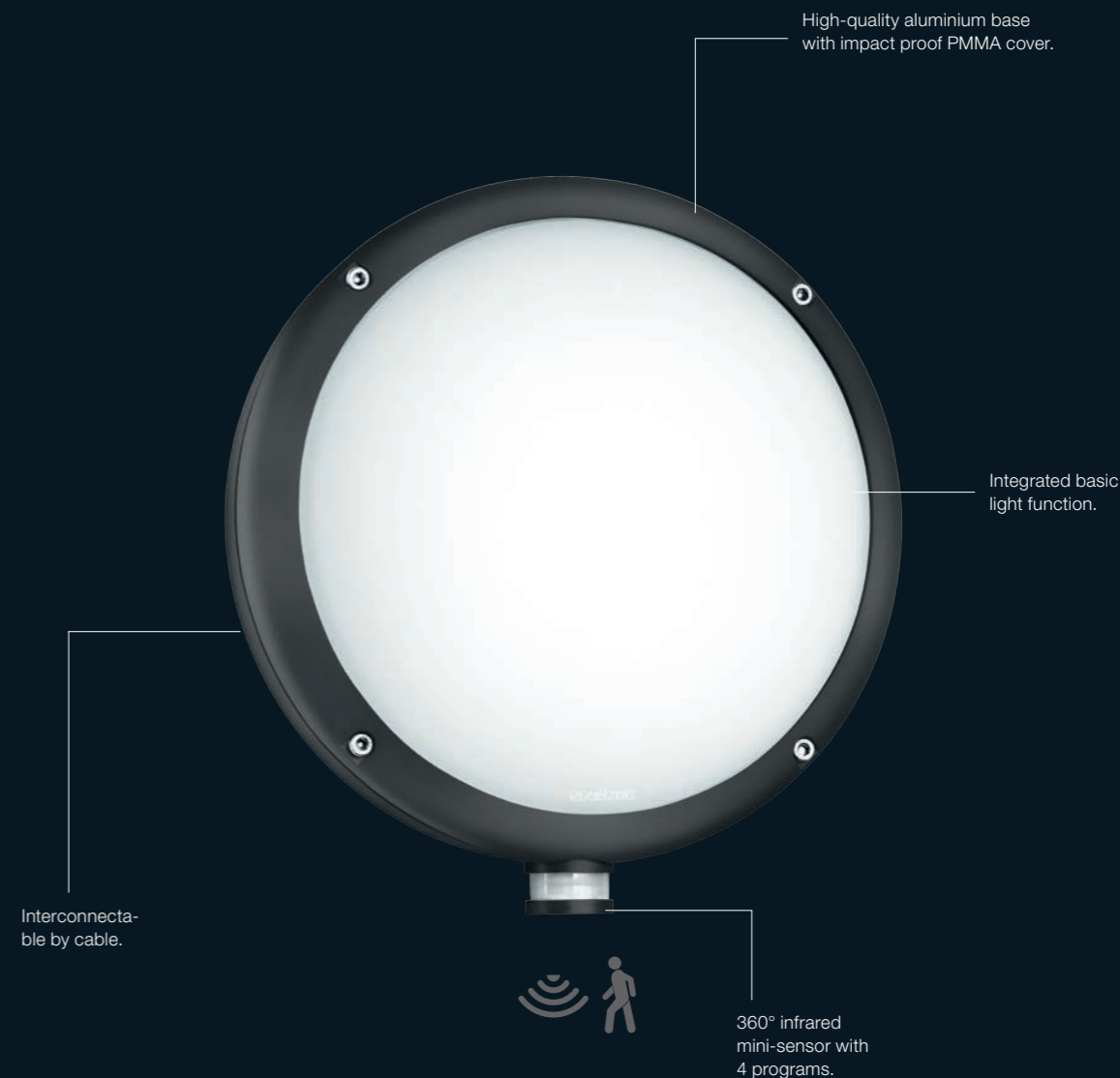

L 331 LED
With mesh guard for
the cover.

Quality and service



STEINEL brand

- STEINEL is specialist for sensor technology since 1989
- German engineering.
- Produced in Europe.



5 years of warranty are a long time.
Not for our products.

Everything we sell is not only developed in-house, but made by us too. And only in Europe. We also check every STEINEL product for perfect working order before it leaves the factory. This way, we can guarantee the origin, perfect quality and long life of every product we deliver. With this in mind, we send out a signal that's seen nowhere else in the industry: a 5-year manufacturer warranty on all products from STEINEL Professional.



Certified quality



For us, it goes without saying that all products from STEINEL comply with European safety standards. Despite involving a huge effort and not always easy from a technical point of view, we are never deterred. Because it is all worth it. So you get certified quality – every step of the way.



Needless to say, our management system holds certification under Quality Standard DIN EN ISO 9001 and Environmental Management Systems Standard DIN EN ISO 14001



STEINEL Customer Service

- Phone: +49 (0)5245 448 188
- E-mail: service@steinel.de
- Monday - Thursday: 8 a.m. - 4.45 p.m.
- Friday: 8 a.m. - 3.30 p.m.



www.steinel.de

- Product overview
- Operating instructions available to download
- Product videos



STEINEL Replacement Parts Service

- Availability guaranteed for genuine STEINEL parts



Free planning service

- PROLog / DIALux / Relux
- Phone: +49 (0) 5245 448 307
- Fax: +49 (0)5245 448 308
- E-mail: objekte@steinel.de



STEINEL Academy

- Our training facility in Herzebrock is available for you and your customers:
Phone: +49(0)5245/448-0
Mail: academy@steinel.de



STEINEL near you

- Our own sales representative is your direct contact.
- Individually tailored POS modules boost awareness and sales.

senses for tomorrow

110062115 03/2018 Subject to technical modification without notice.